

# SAFARI 1D1W

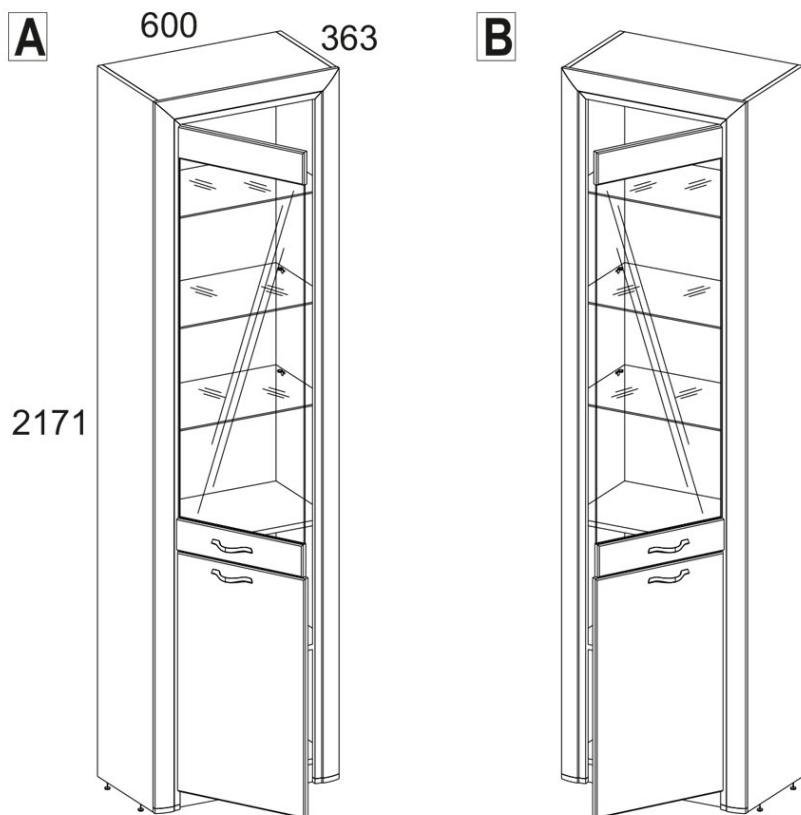

| Kód | L, mm | B, mm | H, mm |   | Balík |
|-----|-------|-------|-------|---|-------|
| 1   | 566   | 335   | 16    | 1 | 1/4   |
| 2   | 566   | 335   | 16    | 2 | 1/4   |
| 3   | 564   | 335   | 16    | 1 | 1/4   |
| 4   | 564   | 325   | 6     | 3 | 1/4   |
| 6   | 2166  | 335   | 16    | 1 | 2/4   |
| 7   | 2166  | 335   | 16    | 1 | 2/4   |
| 8   | 2152  | 80    | 25    | 1 | 3/4   |
| 9   | 2152  | 80    | 25    | 1 | 3/4   |
| 10  | 600   | 80    | 25    | 1 | 3/4   |
| 11  | 1294  | 436   | 16    | 1 | 2/4   |
| 12  | 436   | 730   | 16    | 1 | 2/4   |
| 13  | 1374  | 592   | 2,5   | 1 | 4/4   |
| 14  | 730   | 592   | 2,5   | 1 | 4/4   |
| 25  | 566   | 55    | 16    | 1 | 3/4   |

Pri používaní nábytku je zakázané:

- Umiestňovať nábytok v blízkosti vykurovacích zariadení a vedľa vlhkých stien, ako aj v miestnostiach s relatívnou vlhkosťou vyššou ako 70 %
- Teplota vykurovania nábytkových prvkov nesmie prekročiť +40 °C
- Počas montáže a používania nábytku nestojte nohami na vodorovných paneloch a oknách
- Na čistenie nábytku nepoužívajte chemické čistiace prostriedky
- Nesmie byť vystavený pôsobeniu vody

Vôňa.

Nový nábytok môže mať vôňu materiálov, z ktorých je vyrobený. Vôňa môže pretrvávať až tri týždne po inštalácii.

Na zníženie intenzity vône sa odporúča:

- V prípade čalúneného nábytku – výrobok povysávať a miestnosť vyvetrať.

Opakujte 3 – 4-krát denne

- V prípade skriň – utrite handričkou navlhčenou jemným čistiacim prostriedkom, následne utrite čistou, suchou handričkou a vyvetrajte miestnosť, pričom najprv otvorte všetky dverka a zásuvky výrobku

Opakujte 3 – 4-krát denne. Dôležité! Návod si uschovajte pre prípad opätovnej montáže nábytku alebo reklamácie.

Pri podávaní reklamácie použite označenie v návode.

**VAROVANIE!** Pád nábytku môže spôsobiť vážne alebo smrteľné zranenia v dôsledku pomliaždenín. **VŽDY** upevnite tento nábytok k stene pomocou obmedzovačov. Zabudovaný kolík sa

používa pri tehlových a betónových stenách. Na montáž na stenu použite upevňovacie prvky vhodné pre daný materiál steny. Ak si

nie ste istí, ktorý typ upevnenia je vhodný pre daný materiál steny,

obráťte sa na odborníka alebo špecializovanú predajňu. Za upevňovacie prvky je

v konečnom dôsledku zodpovedný inštalatér. Na ďalšie zníženie rizika vážnych





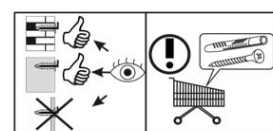
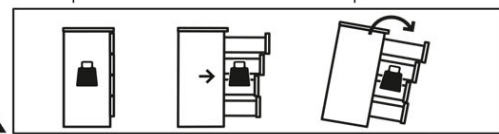

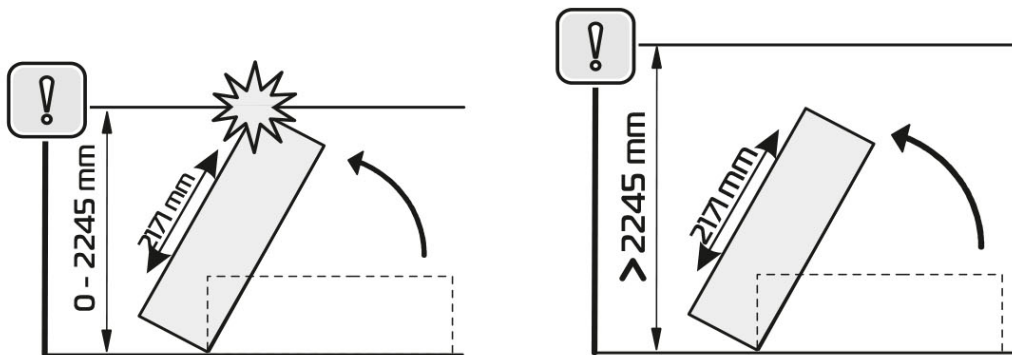
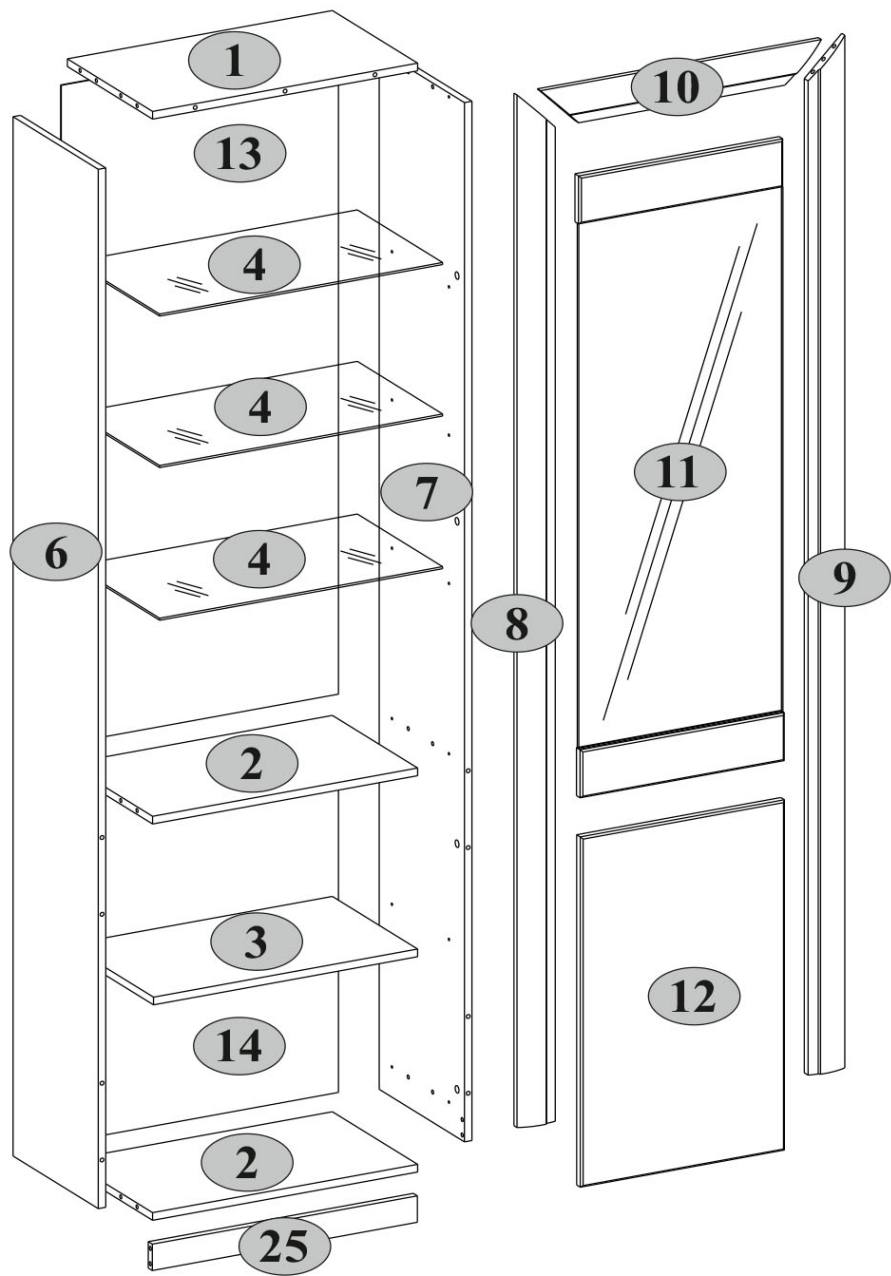

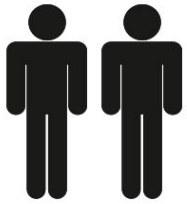



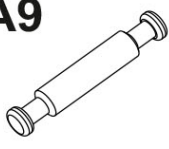

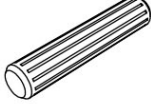
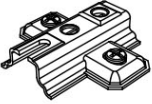
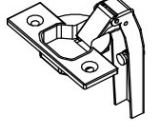

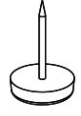

telesných poranení a smrti v dôsledku pádu nábytku:

- Umiestnite najťažšie predmety do spodnej zásuvky
- Neukladajte na hornú časť ťažké predmety
- Nikdy nedovoľte deťom liezť na zásuvky, dverka alebo police
- Nábytok používajte na určený účel





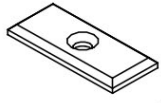

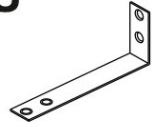
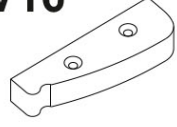

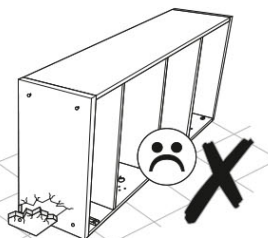
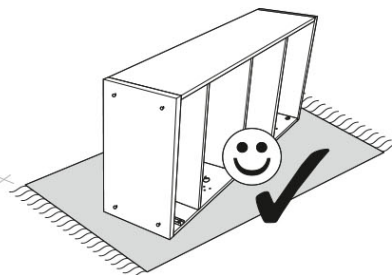
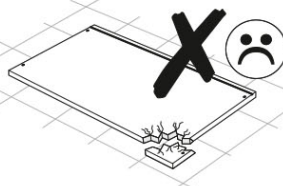
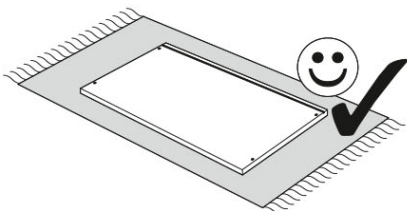
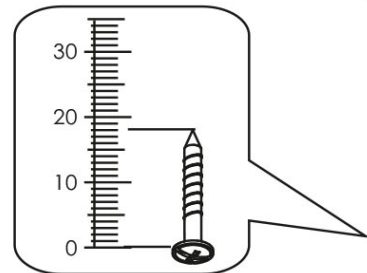
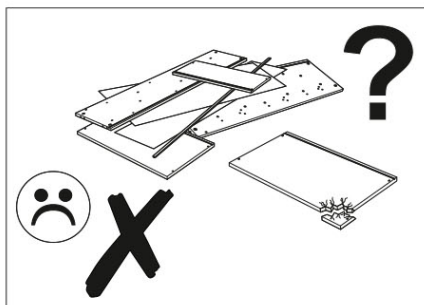
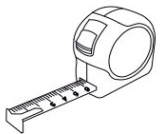
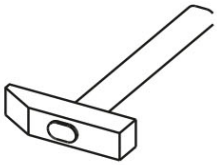
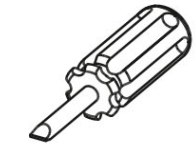
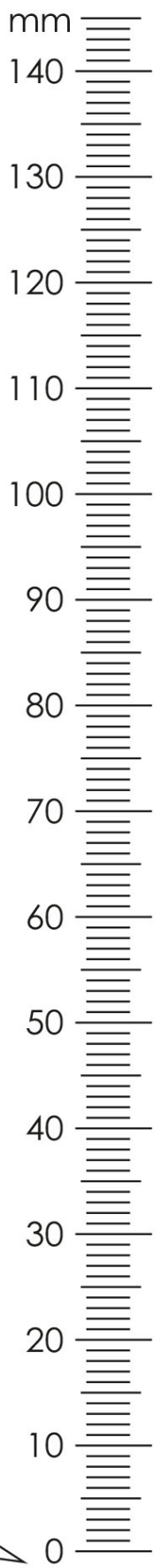

|  |   |  |  |
|--|---|--|--|
| <b>A1.0</b><br><br>5x28 22    | <b>A2</b><br><br>15x13 26      | <b>A9</b><br><br>L-47,4 2      | <b>B5</b><br><br>10x50 1  |
| <b>C1</b><br><br>8x35 29      | <b>D1</b><br><br>4             | <b>E2</b><br><br>4             | <b>G</b><br><br>1,5x26 36 |
| <b>H63</b><br><br>2           | <b>M4</b><br><br>M4x22 4       | <b>N1</b><br><br>4              | <b>P1</b><br><br>Ø5 4     |
| <b>P4</b><br><br>12           | <b>Q</b><br><br>1,5x7 2        | <b>R3</b><br><br>3x20 2        | <b>R5</b><br><br>3x30 4   |
| <b>R23</b><br><br>6,3x13 8  | <b>R102</b><br><br>3,5x16 10 | <b>S3</b><br><br>2           | <b>S5</b><br><br>Ø18 18 |
| <b>U</b><br><br>130x35x15 1 |   | <b>V16</b><br><br>80x25x15 2 |  |



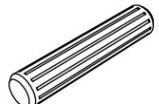

# 1

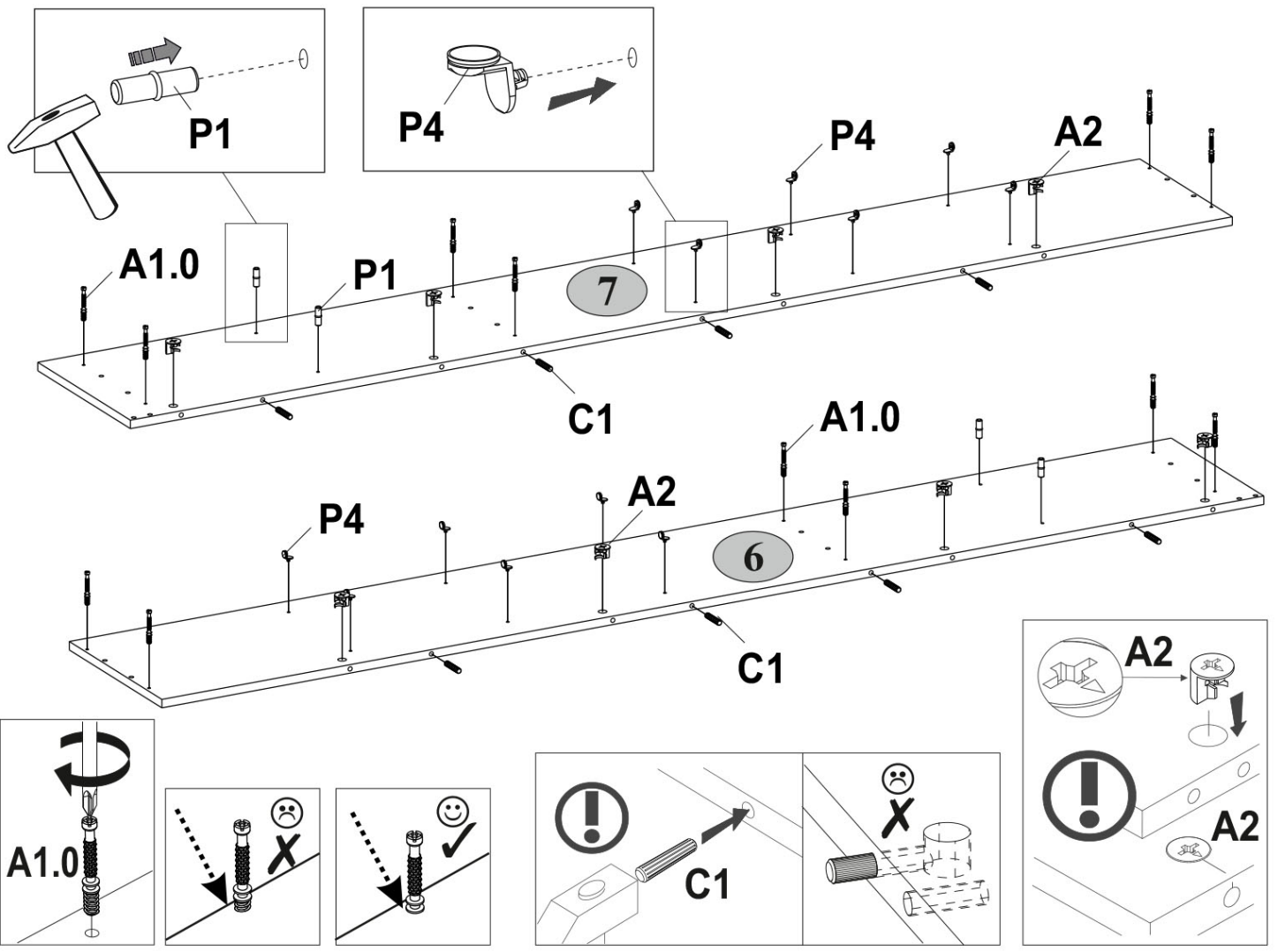
|  |  |   |  |  |
|--|--|---|--|--|
| <b>A1.0</b><br><br>5x28<br>12 | <b>A2</b><br><br>15x13<br>8 | <b>C1</b><br><br>8x35<br>8 | <b>P1</b><br><br>Ø5<br>4 | <b>P4</b><br><br>12 |
|--|--|---|--|--|

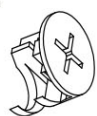

# 2

|  |   |
|--|---|
| <b>A2</b><br><br>15x13<br>6 | <b>C1</b><br><br>8x35<br>5 |
|--|---|

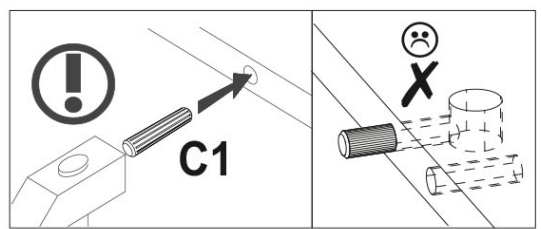
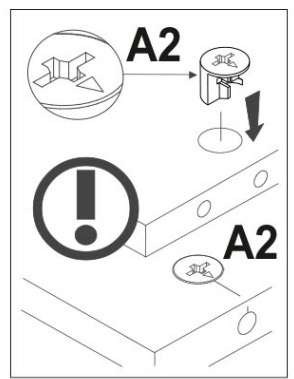
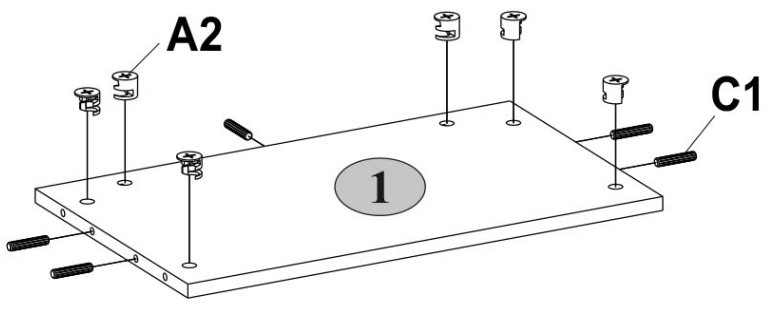





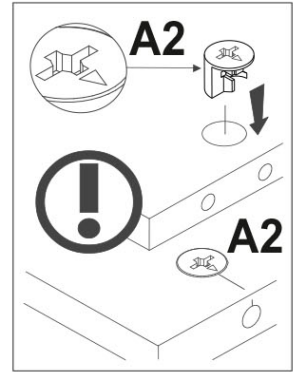
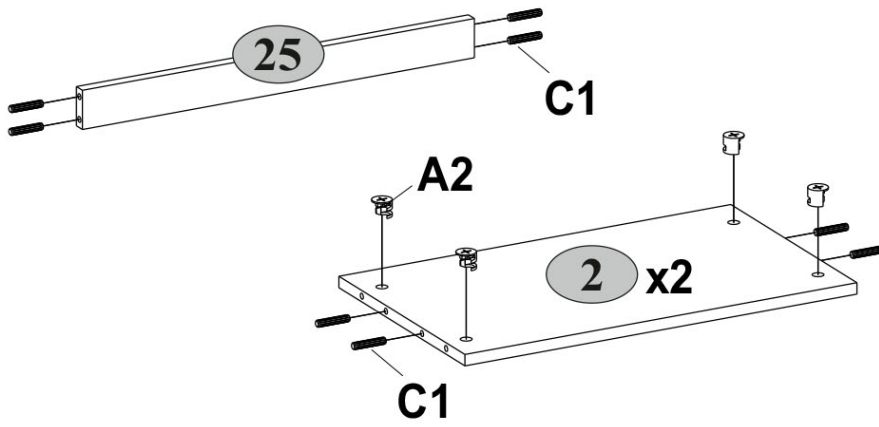
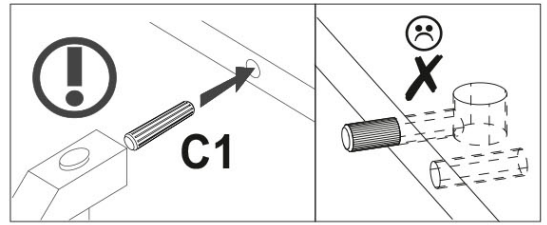
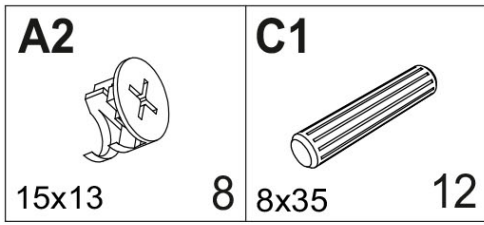

**3**

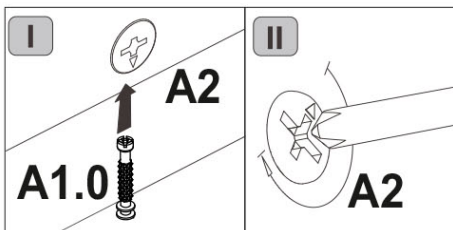
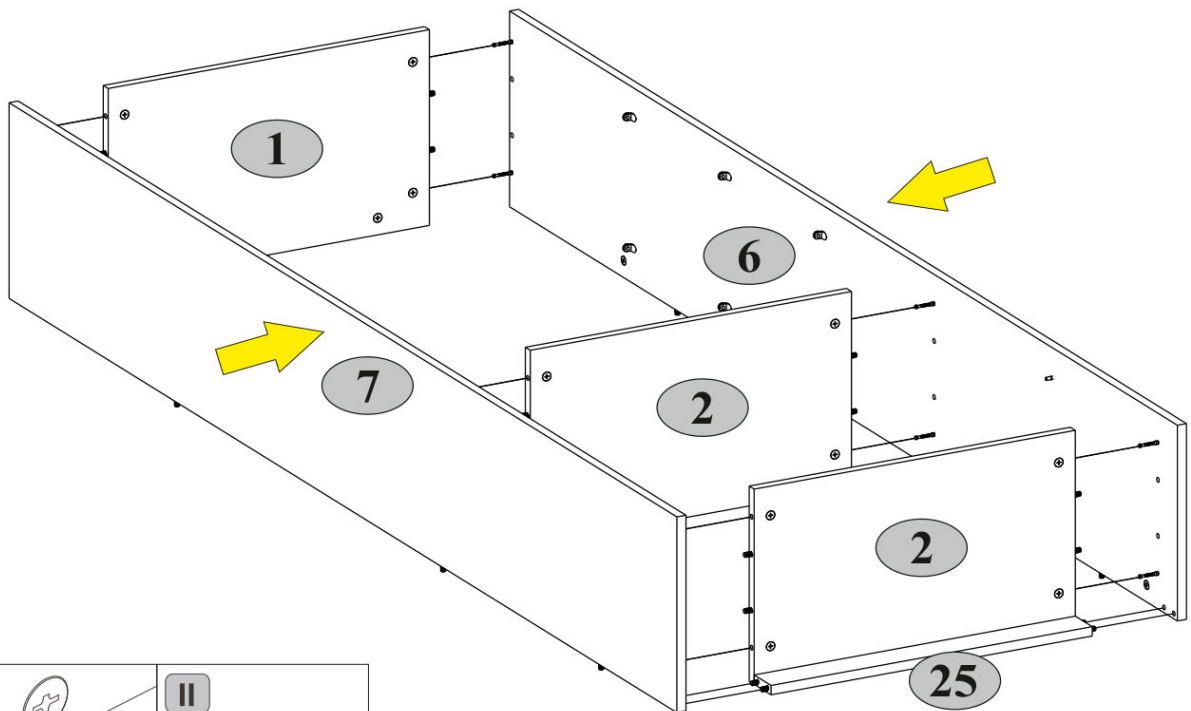

**4**





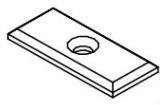

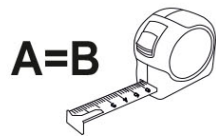
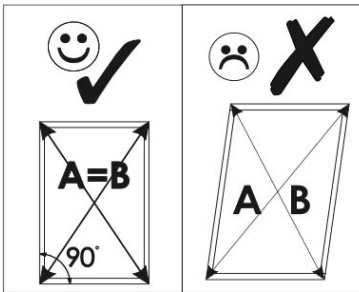
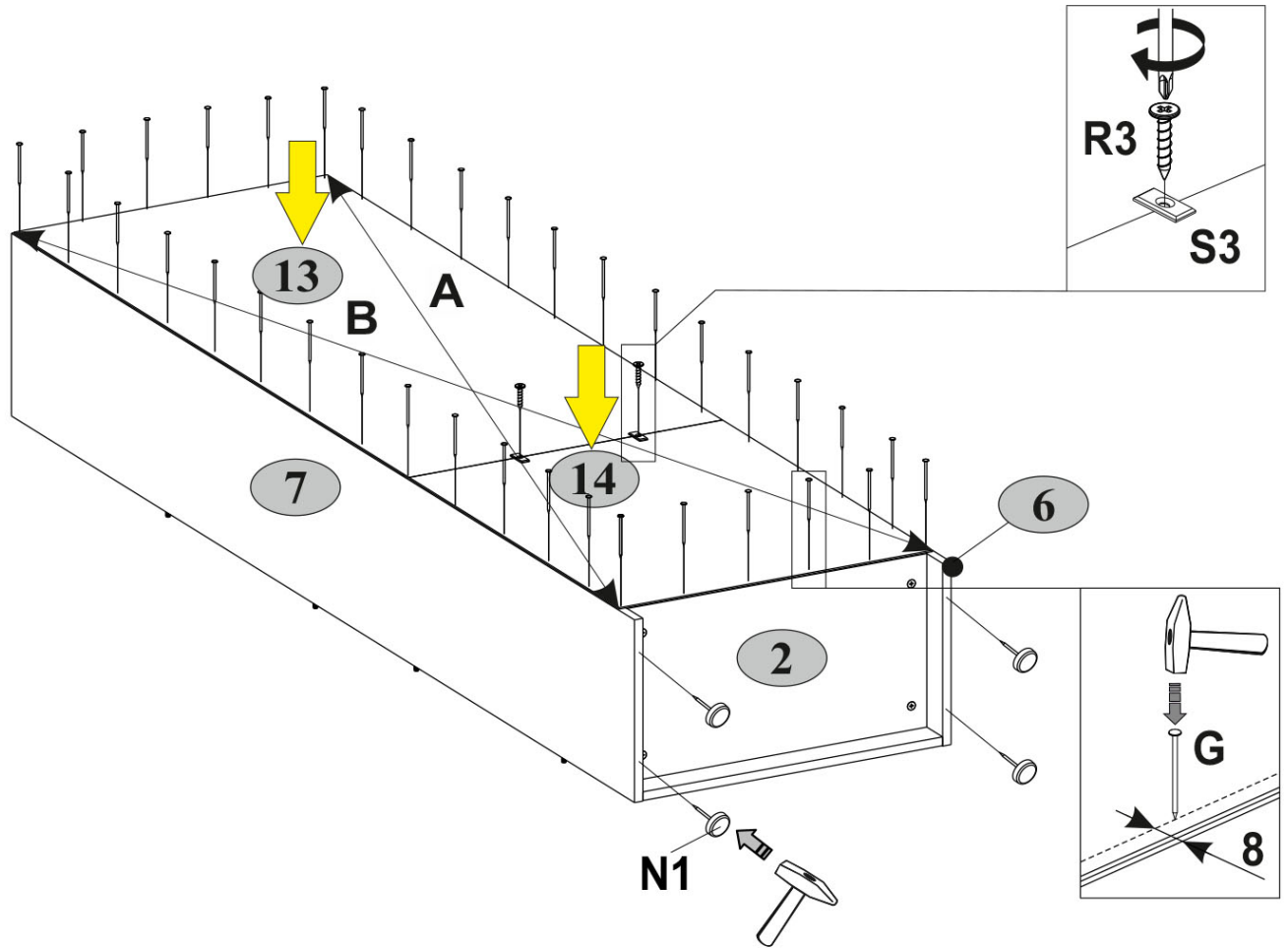
**5**

|   |   |   |  |
|---|---|---|--|
| <b>G</b><br><br>1,5x26<br>36 | <b>N1</b><br><br>4 | <b>R3</b><br><br>3x20<br>2 | <b>S3</b><br><br>2 |
|---|---|---|--|

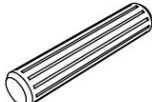

**6**

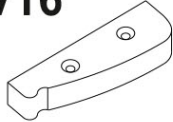
|  |  |   |  |   |  |
|--|--|---|--|---|--|
| <b>A1.0</b><br><br>5x28<br>10 | <b>A2</b><br><br>15x13<br>4 | <b>A9</b><br><br>L-47,4<br>2 | <b>C1</b><br><br>8x35<br>4 | <b>R5</b><br><br>3x30<br>4 | <b>V16</b><br><br>80x25x15<br>2 |
|--|--|---|--|---|--|

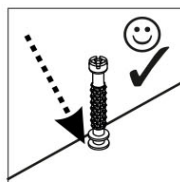
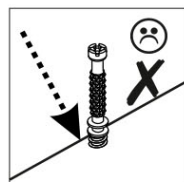
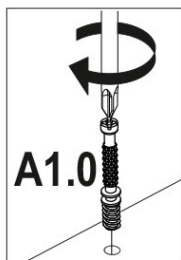
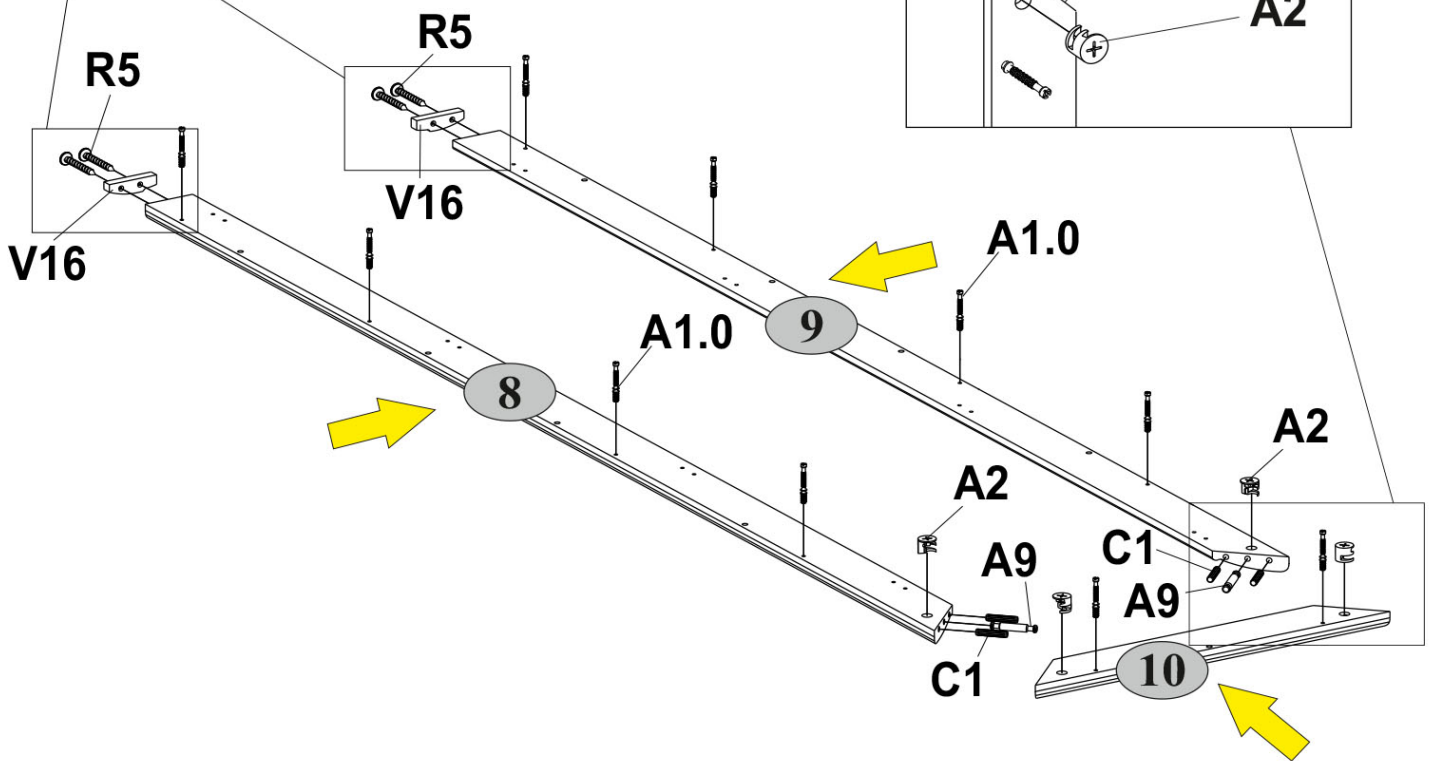
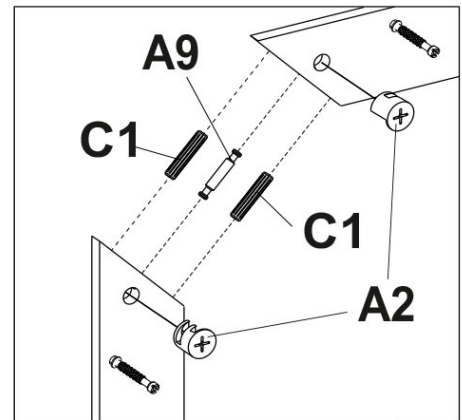
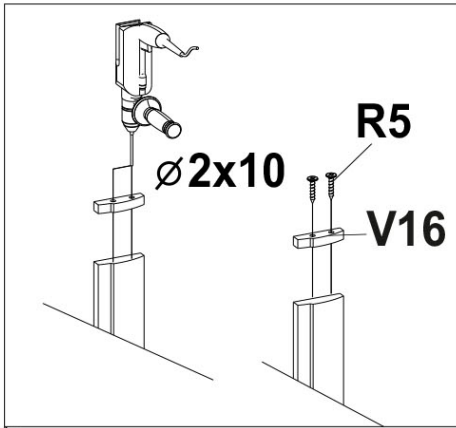



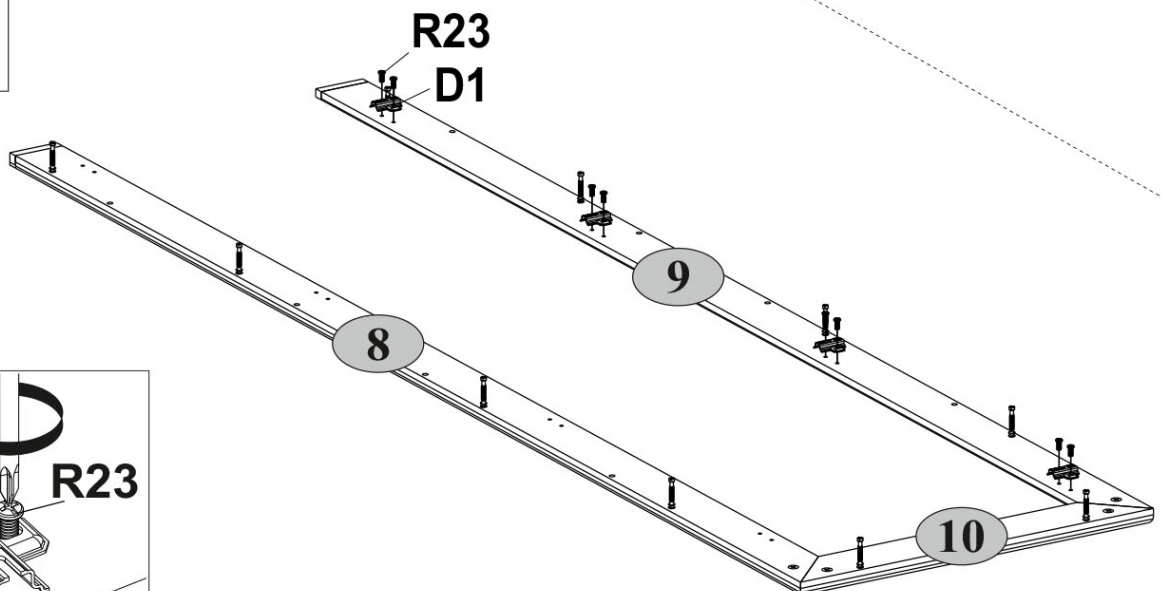
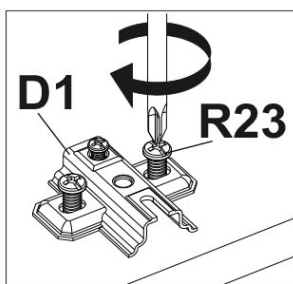
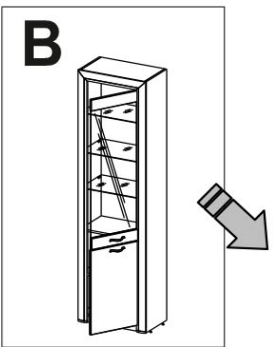
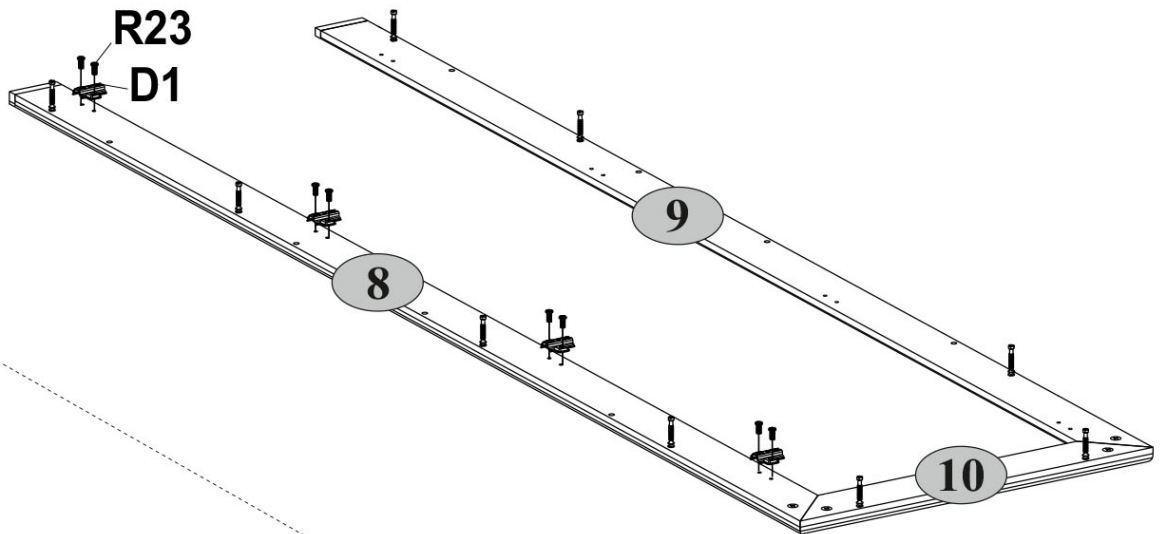
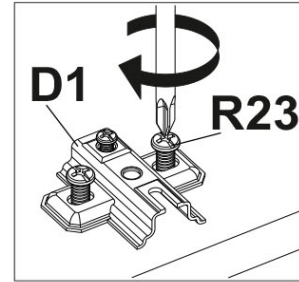
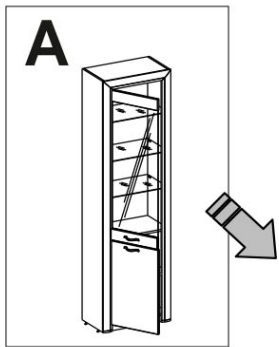
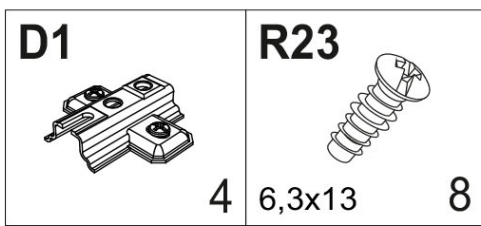

**7**



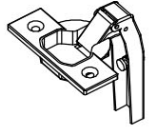

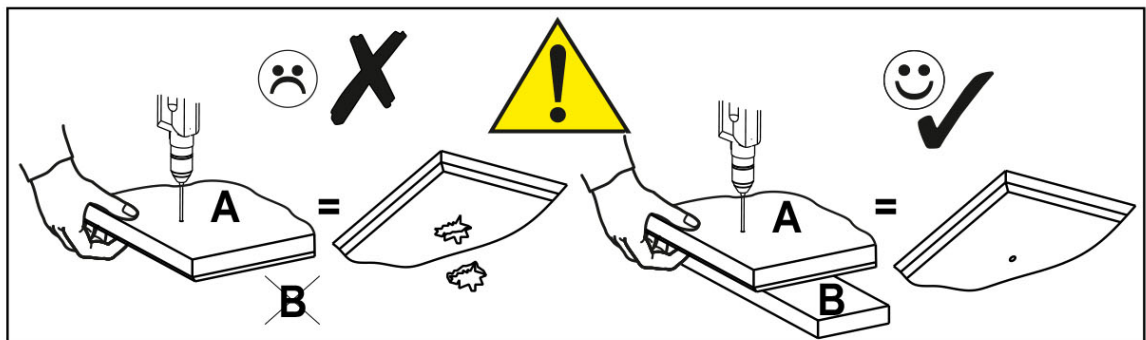
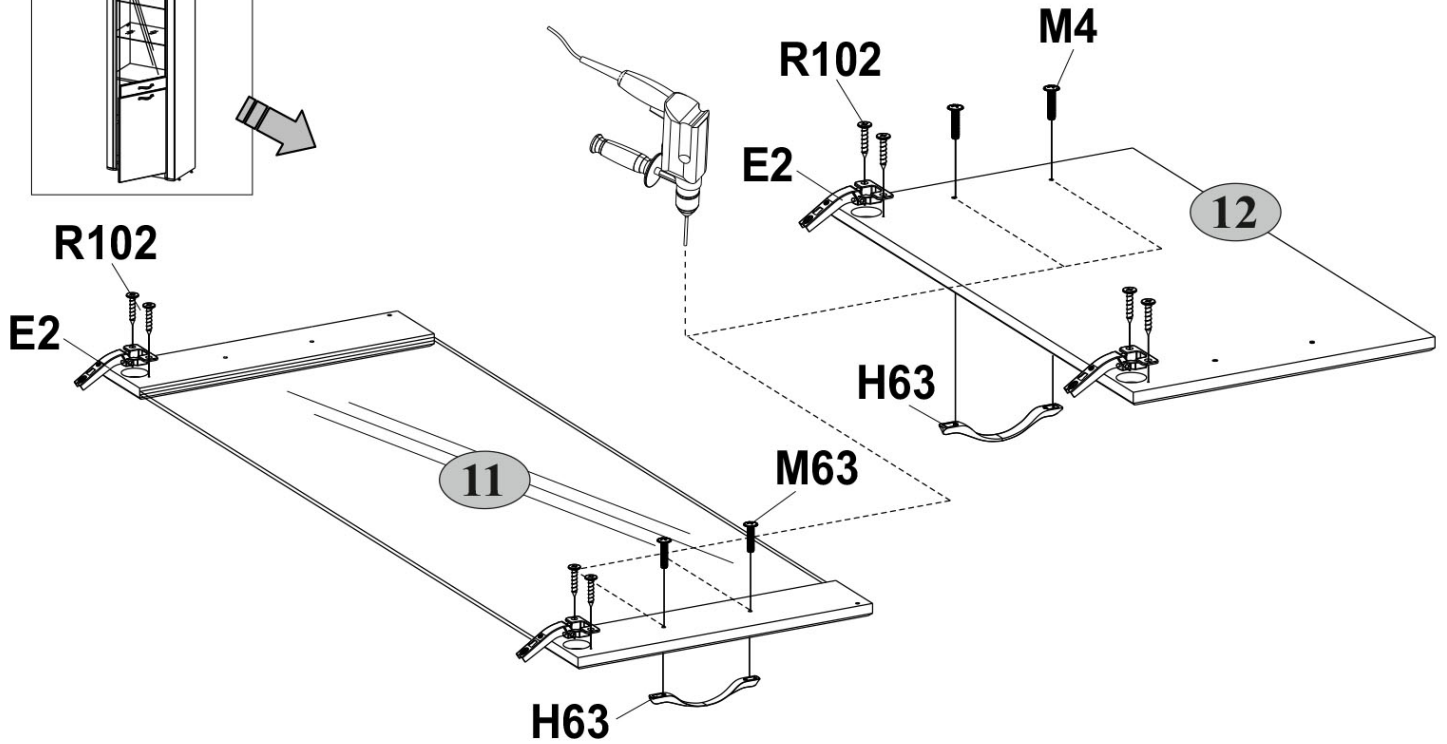
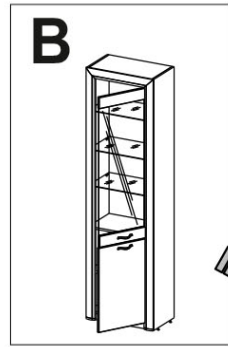
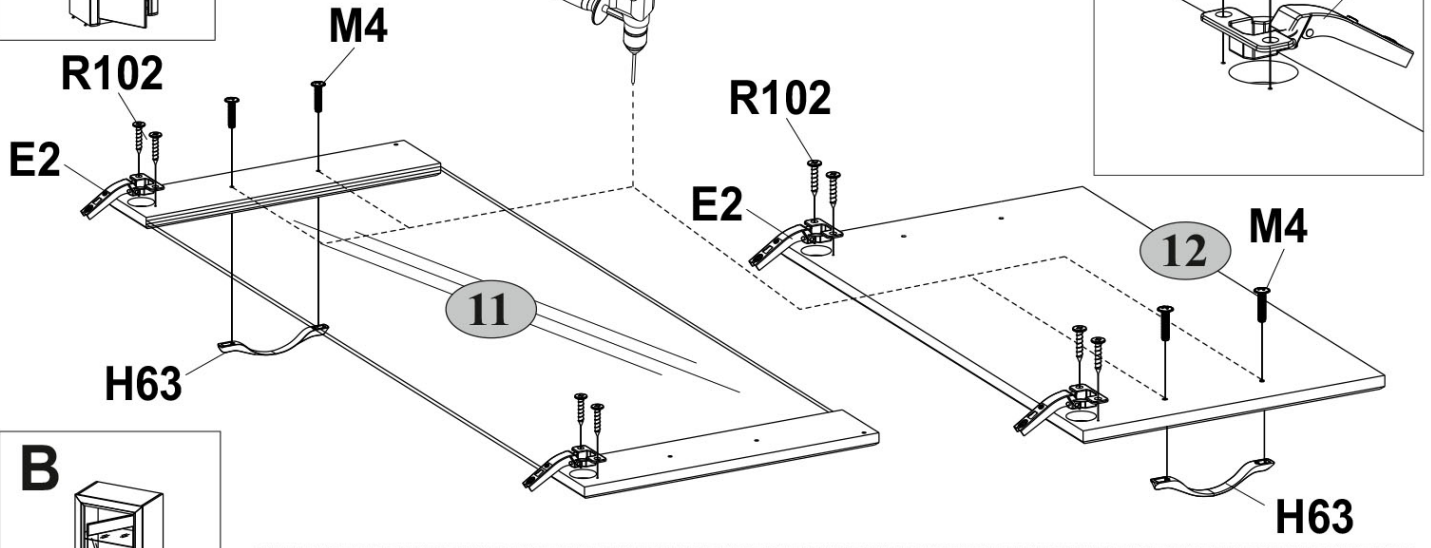
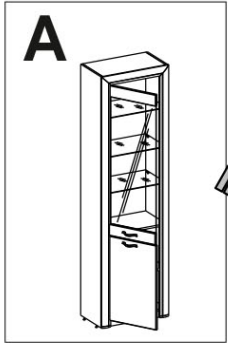

**8**

|   |  |   |  |
|---|--|---|--|
| <b>E2</b><br><br>4 | <b>H63</b><br><br>2 | <b>M4</b><br><br>M4x22 4 | <b>R102</b><br><br>3,5x16 8 |
|---|--|---|--|



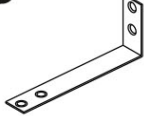

**9**

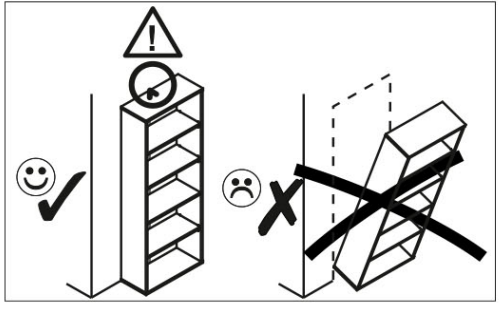
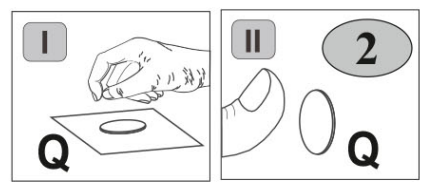
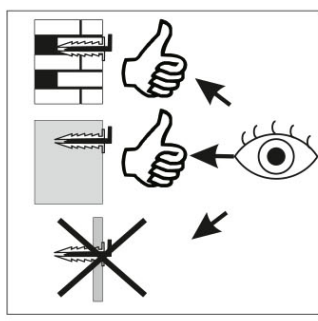
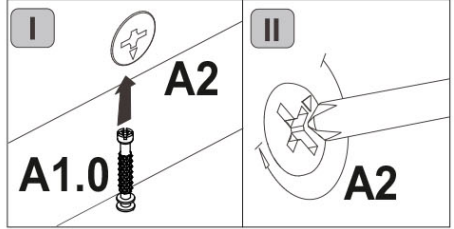
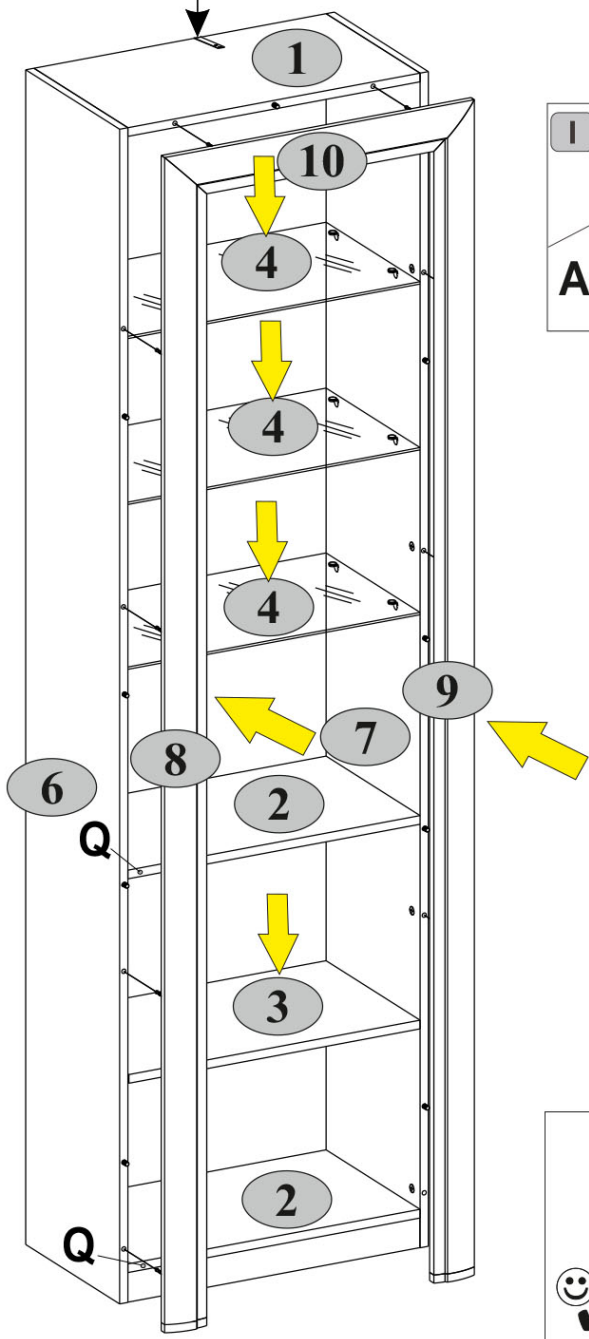
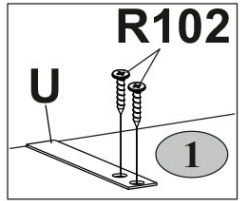
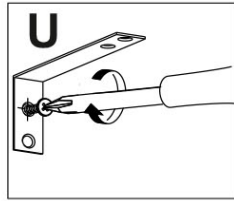
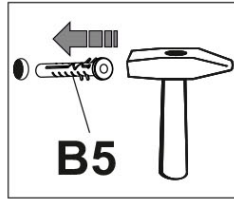
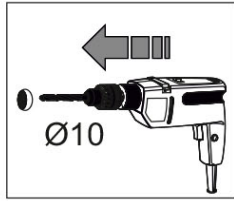
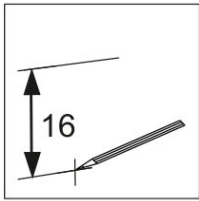
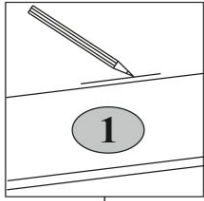
|  |   |   |   |
|--|---|---|---|
| <b>B5</b><br><br>10x50    1 | <b>U</b><br><br>130x35x15    1 | <b>Q</b><br><br>1,5x7    2 | <b>R102</b><br><br>3,5x16    2 |
|--|---|---|---|

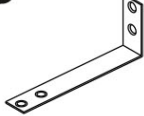

**9**

|  |   |   |   |
|--|---|---|---|
| <b>B5</b><br><br>10x50      1 | <b>U</b><br><br>130x35x15      1 | <b>Q</b><br><br>1,5x7      2 | <b>R102</b><br><br>3,5x16      2 |
|--|---|---|---|

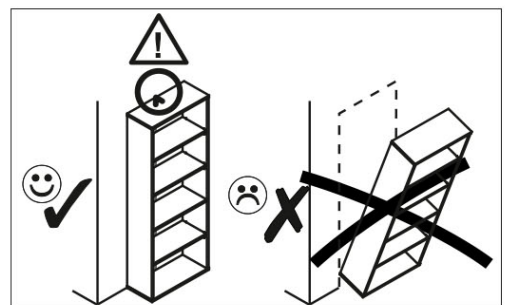
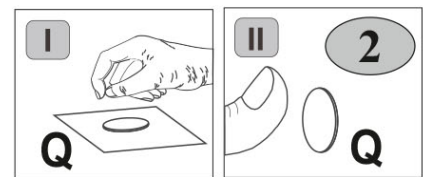
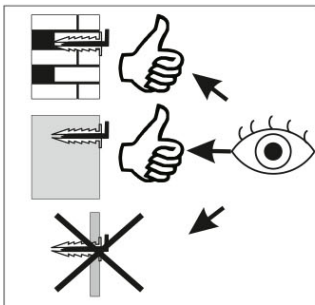
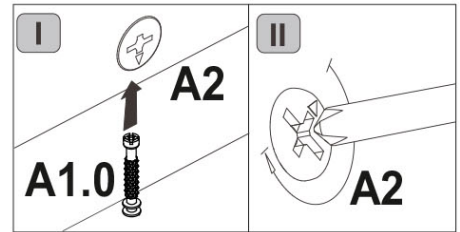
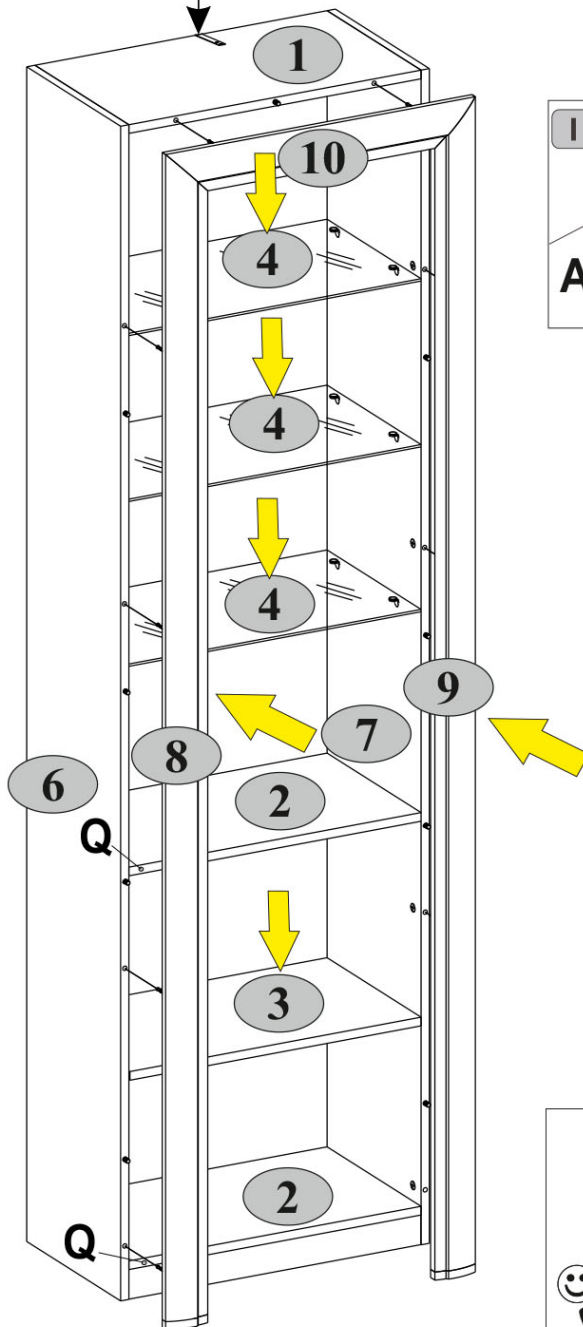
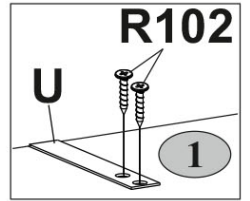
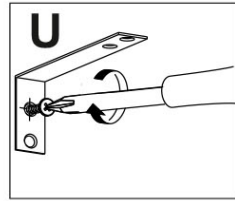
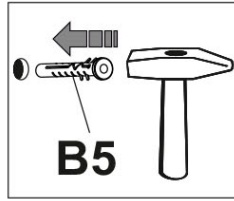
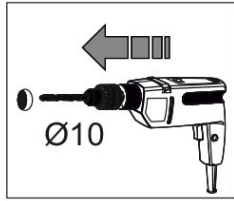
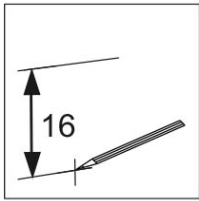
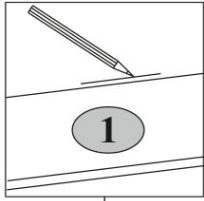

**10**

**S5**



Ø18

18

**A**

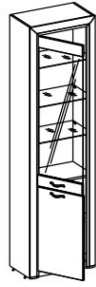

**B**

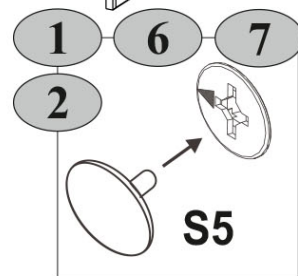
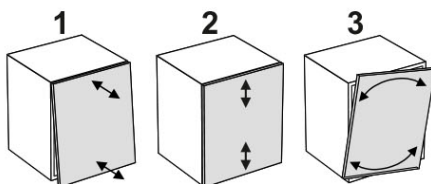
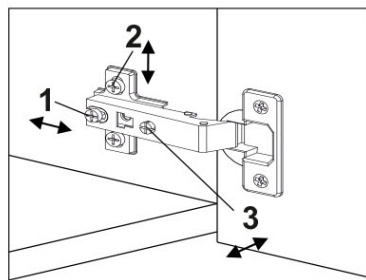
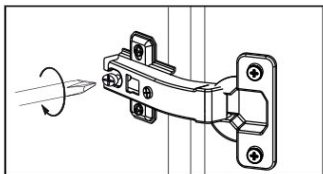
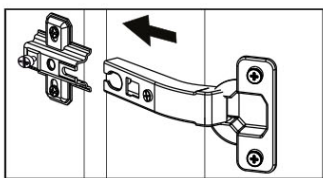
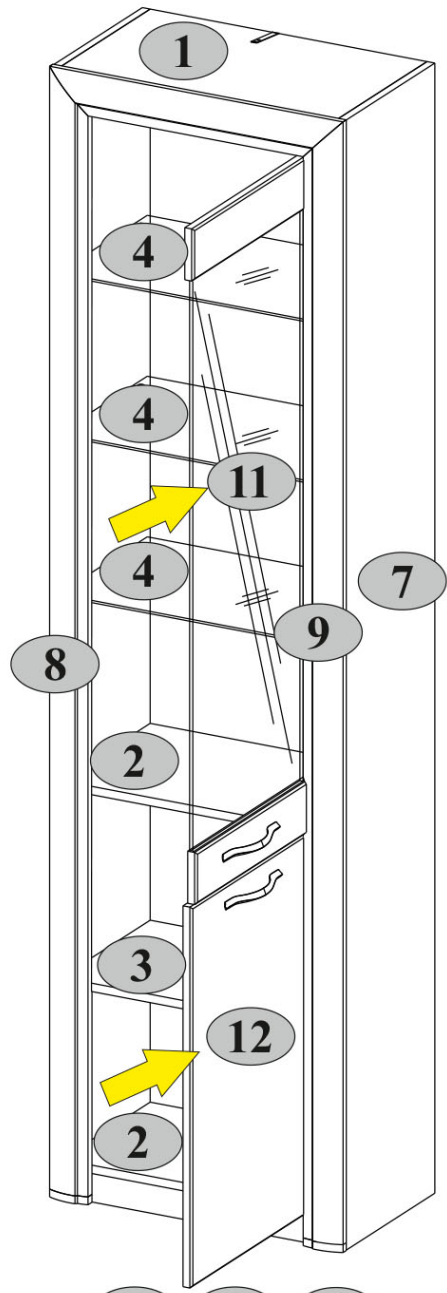
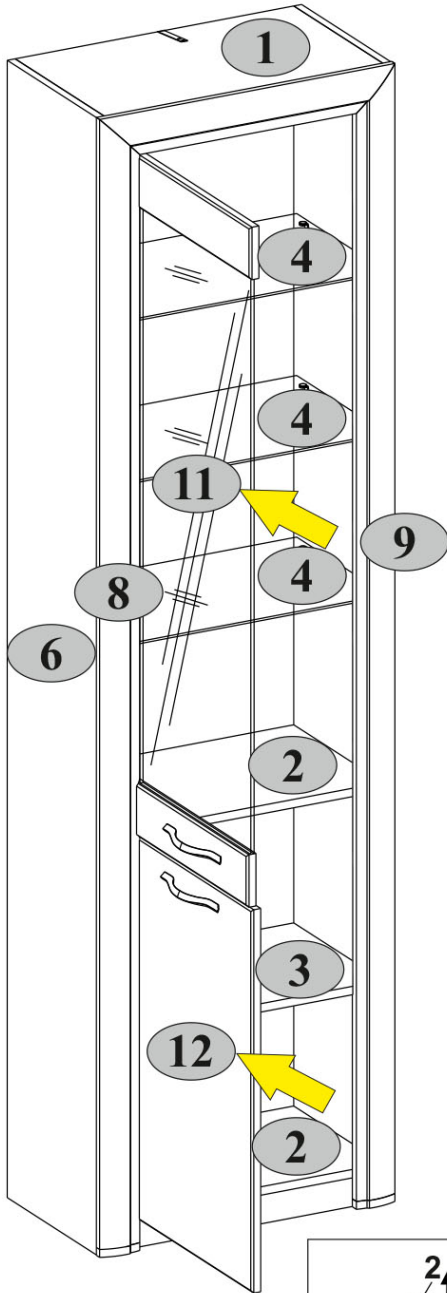
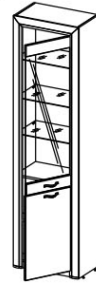

**max. 5 kg**